

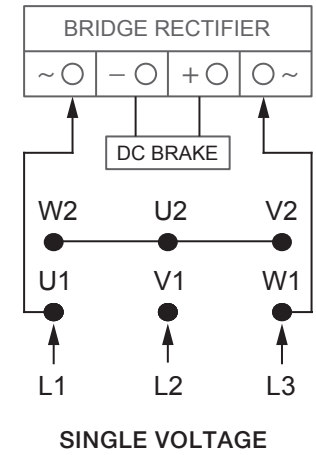

Model **BMM112MA6F-B5**

MFG PN: TAX112M-6-F

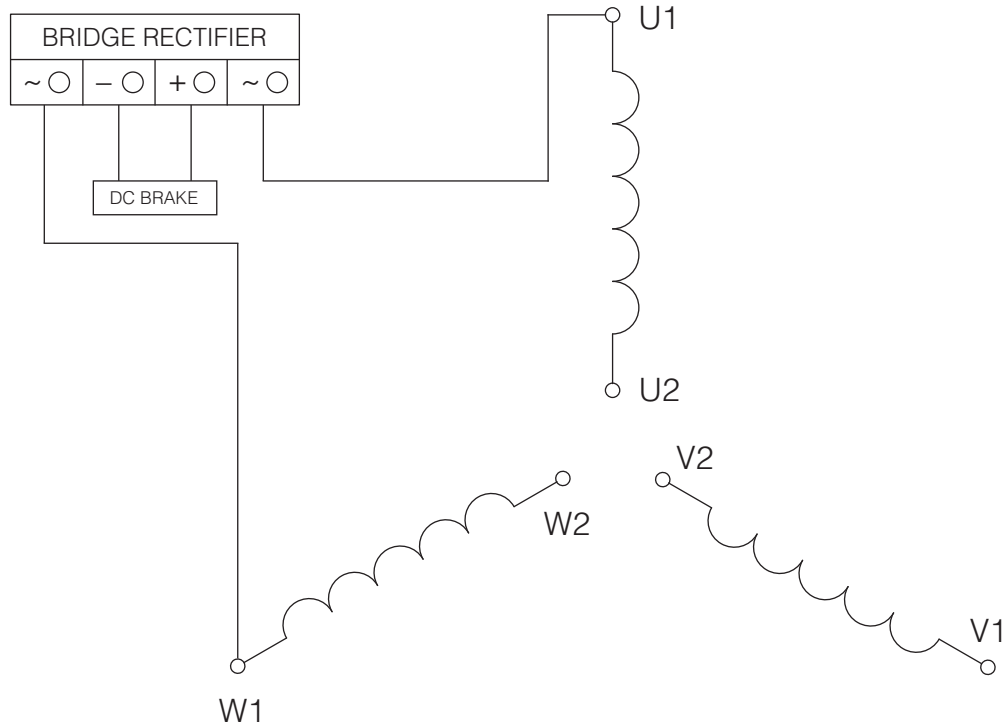

NOTES:

1. CCW ROTATION FACING ODE FOR CONNECTIONS SHOWN
2. TO REVERSE ROTATION, SWAP ANY TWO INPUT LINES
3. WHEN MOTOR IS IN F1 POSITION, LEADS INDICATED WITH "*" EXIT THE CASING ABOVE THE CENTER LINE OF THE MOTOR, THE REMAINING LEADS EXIT BELOW THE CENTER LINE
4. LEADS MUST BE NUMBERED AND COLORED AS SHOWN
5. DIAGRAMS FOR REFERENCE ONLY



IEC 3Ø Y 6-Lead/6-Post Single Voltage

DRAWING NUMBER:

IEC-3-6-Y-BRK

CONNECTION:

Y

NUMBER OF LEADS:

6

THERMAL PROTECTION:

Optional

ISSUED DATE

09/09/19

METRIC IE1/IE3 BRAKE MOTORS